

HI 720

Conductivity Process Digital Controller

with Inductive Probe



HANNA HI 720

- Measurement and control of conductivity or concentration
- Concentration can be measured as TDS (fixed ratio) or through custom conductivity/temperature concentration curves
- Customizing temperature coefficient table and NaCl temperature compensation according to IEC 746-3, in addition to the standard linear compensation
- Auto-ranging
- Display reading offset adjustment for temperature
- Temperature level alarm
- Cleaning in place activated through two cleaning commands, or triggered by a variety of events
- Hold management, including a digital input to enter the hold mode through an external trigger
- Conductivity probe check
- Digital transmitter input
- Pt100 or Pt1000 temperature sensor with automatic recognition and damage test
- Calibration time-out
- Logging of the last 100 error, configuration and cleaning events
- Alarm configuration can be customized: different errors can lead different actions (alarm relay activation, fault current, hold mode, automatic cleaning, SMS message)
- Alarm fault current (3.6 mA or 22 mA)
- SMS messages sending
- RS485 communication with additional capabilities, such as error log file downloading and cleaning commands
- Daily programmable control timing
- Diagnostic features
- Password protection

In-Line Cleaning

The cleaning feature allows an automatic cleaning action of the probe. To perform cleaning, the controller activates an external device (pump). Cleaning actions never take place if no relay is configured for cleaning.

Cleaning can be of two types:

- Simple cleaning: with water only, it can be triggered only by a timer (periodical cleaning) or by an error for which a cleaning action can be configured.
- Advanced cleaning (optional): with water and detergent, it can be triggered by the following events:
 - > Timer
 - > Digital input or RS485 command (external trigger)
 - > Timer and digital input or RS485 command (external trigger)
 - > Timer masked by the digital input (i.e. disabled when the digital input is on)
 - > Error for which a cleaning action can be configured



Inductive Probe

Calibration Mode

The controller is factory calibrated for temperature as well as for the analog outputs. The user should periodically calibrate the instrument for the conductivity range.

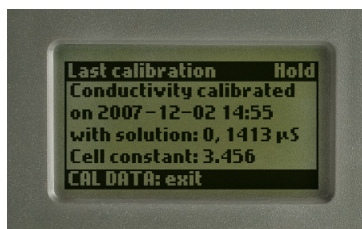

Last Calibration Data Viewing Mode

The following data about the last calibration is stored in the EEPROM:

- Date & time of last conductivity calibration
- Calibration point(s)
- Cell constant or installation factor value

Control Mode

The control mode is the normal operational mode for this meter. During control mode HI 720 fulfills the following main tasks:

- Convert information from conductivity and temperature inputs to digital values, and show them on the display
- Control relays and generate the analog outputs as determined by the setup configuration
- Display alarm condition
- Perform cleaning actions according to the relay configuration
- Start & stop hold mode according to the programmed control timing
- RS485 management

In addition, the meter can log working data. This data includes:

- Conductivity and temperature measured values
- Last calibration data
- Setup configuration
- Event data

Diagnostic Mode

The diagnostic mode allows the user to check if some errors are still active on the controller, or view the event log file.

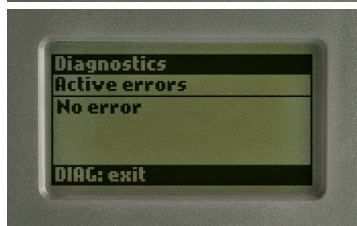
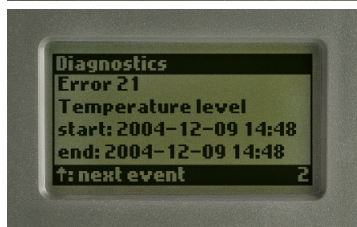
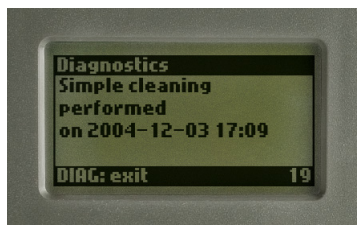

Hold Mode

This function is started by:

- Calibration
- Setup
- Cleaning in place
- Hold digital insulated input (there are two digital insulated inputs: one for hold mode and one for the advanced cleaning) when it is on; normally the signal level is polled at least every 4 seconds
- Proper key combination (CFM and up arrow keys together) for service; the same key combination is used both to start and stop the hold mode (the key combination acts in the same way as the hold digital input)
- Daily programmable control timing
- An error event
- The hold start/stop RS485 command



Communication

For remote interaction with your controller, enter the setup mode, confirm the "Communication" menu, and select the "Connection type" from among 4 options:

- PC
- HI 504900 GSM module
- HI 504901 GSM supervisor
- HI 504902 Modem

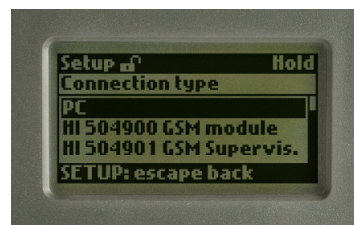

PC Communication

Choose the "PC" connection type to communicate with the controller from your PC, through an RS485 network and the HI 92500 Windows® compatible software. RS485 standard is a digital transmission method that allows long lines connections. Its current-loop system makes this standard suitable for data transmission in noisy environments.

Short Messaging Service (SMS)

It is possible to connect the controller to a GSM cellular engine (HI 504900 or HI 504901). This connection enables the instrument to send SMS to one (or two) cellular phone(s) and through this feature the device can be monitored at any moment. Moreover, if an error occurs on the HI 720, it is possible to receive an alarm SMS which immediately advises about the problem.

Modem Connection

A modem connection can be established between HI 720 and a remote computer over telephone line. Two different types of remote connection are possible:

- Over the GSM network, connecting the HI 504900 cellular module to the RS485 port of HI 720.

Note A SIM card able to receive data calls must be used.

- Over a standard analog telephone line, connecting the HI 504902 modem module to the HI 720 RS485 port.

HI 720

Conductivity Process Digital Controller

with Inductive Probe

Theory of Operation

This instrument allows conductivity measurements without any electrical contact between electrodes and process fluid. The measurement is based on inductive coupling of two toroidal transformers by the liquid.

The instrument supplies a high frequency, reference voltage to the "Drive Coil", and a strong magnetic field is generated in the toroid.

The liquid passes through the hole in the toroid and can be considered as one turn secondary winding. The magnetic field induces a voltage in this liquid winding, the current induced in the flow is proportional to this voltage, and the conductance of the liquid one-turn winding is in accordance to Ohm's law.

The conductance is proportional to the specific conductivity and a constant factor determined by the sensor geometry and installation.

The liquid also passes through the second toroid and therefore the liquid turn can be considered as a primary winding of the second toroidal transformer. The current in the liquid will create a magnetic field in the second toroid, and the induced current can be measured as an output.

The output current of this "Receive Coil" is therefore proportional to the specific conductivity of process liquid.

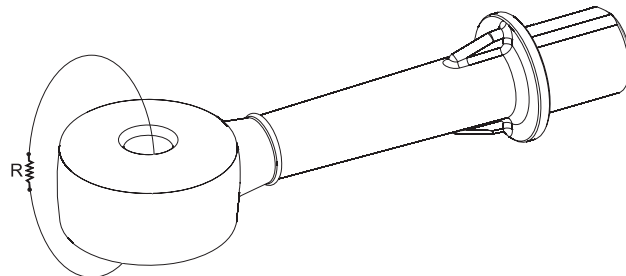
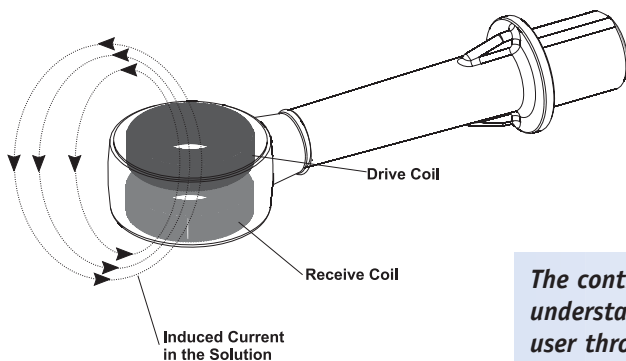

For an inductive cell, the cell constant is defined as the measured conductivity, obtained by making a loop through the sensor with a resistor R, multiplied by that R value.

The cell constant depends only on the sensor geometry. However, when the probe is immersed in a liquid, the induced current in the solution is affected by the piping or any other container where the probe is inserted. This effect is negligible when there is an area of at least 3 cm of liquid around the cell.

Otherwise, it is necessary to multiply measurements by the installation factor: $\text{Conductivity} = (\text{cell constant})(\text{installation factor})/(\text{measured resistance})$. The installation factor is < 1 for conductive piping/containers, and > 1 for nonconductive piping/containers.

Since this type of sensor has no electrodes, common problems such as polarization and contamination are eliminated and will not affect the performance of the electrodeless sensor.

The controllers are equipped with a graphic display that is understandable and straightforward. Simple messages guide the user through all operations and parameter settings.

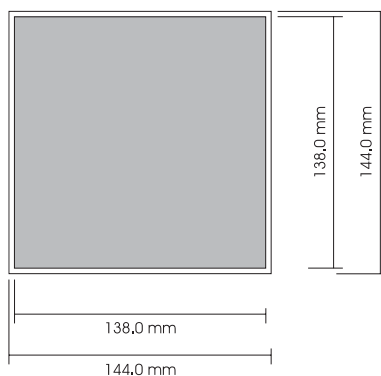
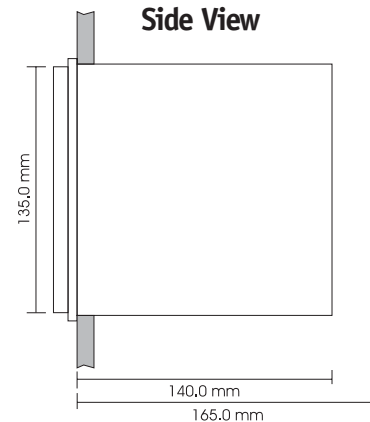
Mechanical Dimensions**Front View****Side View**

Conductivity Process Digital Controller

with Inductive Probe

SPECIFICATIONS

HI 720

Range	0 to 2000 mS/cm (auto-ranging); -30 to 130°C / -22 to 266°F
Resolution	1 µS/cm (0 to 1999 µS/cm); 0.01 mS/cm (2.00 to 19.99 mS/cm); 0.1 mS/cm (20.0 to 199.9 mS/cm); 1 mS/cm (200 to 2000 mS/cm); 0.1°C / 0.2°F
Accuracy (@20°C/68°F)	±2% f.s. (conductivity) / ±0.5°C / ±1°F
Temperature Compensation	Automatic or manual, -30 to 130°C
Temperature Probe	3-wire or 2-wire Pt100 or Pt1000 sensor with automatic recognition and damage test
Digital Input	Digital Transmitter, Hold & Advanced Cleaning inputs
Digital Output	1 digital insulated contact closed upon Hold mode
Analog Output	1 or 2 independent outputs; 0-22 mA (configuring as 0-20 mA or 4-20 mA)
Digital Serial Output	RS485
Dosing Relay	1, 2, 3 or 4 electromechanical relays SPDT; 5A-250 Vac, 5A-30 Vdc (resistive load); fuse protected: 5A, 250 V fuse
Alarm Relay	1 electromechanical relay SPDT; 5A-250 Vac, 5A-30 Vdc (resistive load); fuse protected: 5A, 250 V fuse
Installation Category	II
Power supply (depending on model)	24 Vdc/ac, or 115 Vac or 230 Vac or 100 Vac ±10%, 50/60 Hz; fuse protected: 400 mA, 250 V fast fuse
Power Consumption	10 VA
Max Oscillation Frequency	8 MHz
Environment	0 to 50°C (32 to 122°F); RH max 85% non-condensing
Enclosure	Single case 1/2 DIN
Weight	Approx. 1.6 kg (3.5 lb.)

ORDERING INFORMATION for HI 720

Each **HI 720** model is supplied complete with mounting brackets and instructions.

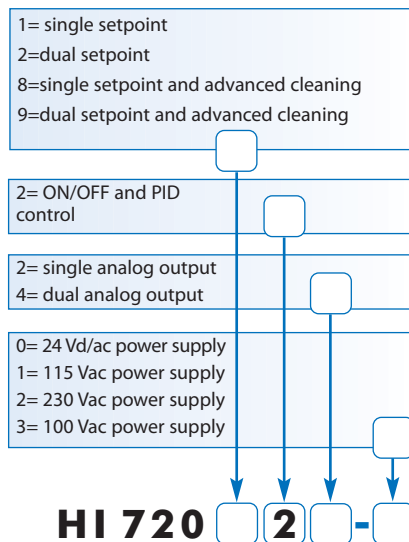

Example:

HI 720124-1

EC controller with single setpoint, ON/OFF and PID control, dual analog output and 115 Vac power supply.



ORDERING INFORMATION for HI 7650

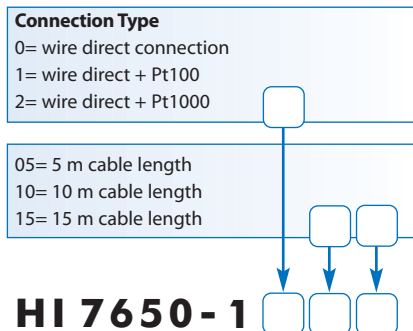

SPECIFICATIONS

HI 7650 Inductive Conductivity Probe

Measuring Range	0 to 2000 mS/cm
Accuracy	±2% f.s.
Cell Constant	approx. 2.4 cm ⁻¹
Protection Class	IP67
Temperature Sensor	Pt100 to Pt1000 (depending on model)
Temperature Response	90% of the final value, approx 10 minutes
Required Pipe Diameter	>80 mm (consider installation factor for pipe with diameter < 125 mm)
Dimensions (probe only)	40 x 190 x 55 mm (1.57 x 7.48 x 2.16"); Head: 32 x OD 55 mm (1.25" x OD 2.16")
Weight (probe only)	approx. 330 g (11.64 oz.)

PROBES

- HI 7610** Stainless steel Pt100 probe with 5 m (16.5') cable
- HI 7611** Glass Pt100 probe with 5 m (16.5') cable
- HI 7620** Stainless steel Pt1000 probe with 5 m (16.5') cable
- HI 7621** Glass Pt1000 probe with 5 m (16.5') cable

PROBE CLEANING SOLUTIONS

- HI 7061M** General cleaning solution, 250 mL
- HI 7061L** General cleaning solution, 500 mL

CONDUCTIVITY CALIBRATION SOLUTIONS

- HI 7030L** 12880 µS/cm, 500 mL
- HI 7031L** 1413 µS/cm, 500 mL
- HI 7034L** 80000 µS/cm, 500 mL
- HI 7035L** 111800 µS/cm, 500 mL
- HI 7039L** 5000 µS/cm, 500 mL
- HI 8039L** 5000 µS/cm, 500 mL

ACCESSORIES

- HI 504900** Hanna GSM module
- HI 504901** Hanna GSM supervisor
- HI 504902** Hanna RS485 modem
- BL Pumps** Dosing pumps with flow rate from 1.5 to 18.3 LPH
- HI 92500** Windows® compatible software
- HI 931002** 4-20 mA Simulator
- HI 98501** ChecktempC temperature tester (range -50 to 150°C)
- HI 98502** ChecktempF temperature tester (range -58 to 302°F)